

USING MANUAL

GT-300 PLUS

VERSION N° GT300-UK06/2025



TABLE OF CONTENTS

1	INTRODUCTION	3
1.1	Components	4
1.2	General view of your device	5
1.3	Connections	8
1.4	Specifications	9
1.5	Installation	9
1.5.1	All models	9
1.5.2	Models with temperature control (N125100, N125200, N125400, N125500, N125600 and N125700)	10
1.5.3	Installation and use of breakable thermocouple (PN 000645)	10
2	GETTING STARTED	11
2.1	State icons	11
2.2	Main Menu	12
2.3	Measure menu	12
2.3.1	Manual measure mode	13
2.3.2	Automatic measure mode	15
2.4	View results menu	18
2.4.1	Show results	18
2.4.2	Export results	19
2.4.3	Delete results	20
2.5	Zero setting	20
2.6	Parameters menu	21
2.6.1	Languages	22
2.6.2	Date / Hour	22
2.6.3	Sounds/Standby/Lighting	23
2.6.4	User Name	23
2.6.5	Units/Density	25
2.6.6	Measuring System	25
2.6.7	Locked Mode	26
2.6.8	Miscellaneous	27
2.6.9	LIMS mode	28
2.6.10	Printing	28
2.6.11	Service	28
2.7	Remote mode menu	29
2.8	Programs menu	29
2.8.1	Create new program	30
2.8.2	Edit program	33
2.8.3	Delete program	33
2.9	Temperature setpoint menu	33
3	MEASURING WITH YOUR DEVICE	34
3.1	Installation of measuring system	34
3.2	Temperature settings	35
4	VERIFICATION OF YOUR DEVICE	35

1 INTRODUCTION

The GT-300 is a device able to measure the gel time of sample while curing process. As viscosity of sample will increase, device will measure it and save data. Later you will be able to plot curve: Viscosity = f(t) after data transfer to computer. When GT-300 is used with RheoTex software, Gel time will be easily given.

The fluid is forced to a shear rate (rotational speed) and the shear stress (motor torque) is measured. The values of shear rate and shear stress then make it possible to calculate the viscosity using the Newton equation and the constants associated with the mobile used.

$$\text{Equation of Newton is: } \eta = \frac{\tau}{\dot{\gamma}}$$

With η for viscosity in Pa.s, τ for shear stress in Pa and $\dot{\gamma}$ for shear rate in s^{-1} .

Shear stress and shear rate are calculated by using constants of each measuring system as:

$$\tau = M \times K_{\tau} \text{ with } M \text{ for motor torque in mNm and } K_{\tau} \text{ in Pa/mNm.}$$

$$\dot{\gamma} = n \times K_D \text{ with } n \text{ for rotational speed in rpm and } K_D \text{ in } s^{-1}/\text{rpm.}$$

The instrument calculates the viscosity by dividing the shear stress by the shear rate for each measuring point. The K_{τ} and K_D constants used depend on the measuring system selected for the measurement.

Viscosity depends on the temperature, then it must be essential that all viscosity values are associated to a reading of the sample temperature, in order to compare viscosity for different samples.

There are some products for which the viscosity, to a constant temperature, stay unchanged, even if we change the shear rate. Those samples are named **Newtonian fluids**, i.e. : Oils, Water, Glycerol, etc...However, many substances have a variation of viscosity in function of speed of shearing, and the Flow Behaviour of those samples could be determined with measuring instruments able to set many speeds of rotation.

The instrument is constituted with a continuous current motor with an optical encoder, in order to warranty a great accuracy of the speed of rotation of bob, on all torque range.

The instrument has an easy touch screen display, on which you could read the **speed, measuring spindle reference, temperature, the measured torque and the dynamic viscosity in mPa.s (=cPoises) or Pa.s.**

The Device GT-300 can be used with disposable hook and cup. All information you need to know to us them are explain in section 3.

1.1 Components

The device is delivered inside a foam protection with power supply to avoid any problem during transport. All other accessories needed to use such as measuring geometries or stand and installation pieces are delivered in another carton.

Here is in detail what is contained in this foam. The device must be dislodged with care in order to prevent any damage.



Model : N125000



Model : N125100, N125400
and N125600.



Model : N125200,
N125500 and N125700

The GT300 (all model) is delivered with software RheoTex, user notice and:



1



2

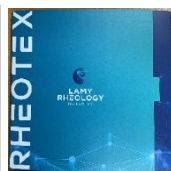

3

- 1- AC power adaptor for measuring head.
- 2- Fixture for hook.
- 3- RheoTex with mini-USB cable

For models with temperature control (excepted N125000):



4



5

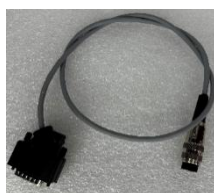

6

- 4- Cable for power supply of temperature unit.
- 5- Cable for connexion of measuring head with programmer (model N125200, N125500 and N125700).
- 6- Cable for reading probe of the temperature control. Then Thermocouple (000645) is ordered, this cable is not present in shipment.

Accessories delivered with the GT300 (according to order):



Aluminium disposable cup (set of 100) PN 700011



Measuring hook 111 (Vol. 50-80mL) (Set of 100) PN 700010



Measuring hook 112 (Vol. 35-50mL) (set of 100) PN 700040



Breakable thermocouple (25 m) PN 000645

Holder for thermocouple (Ref 405000)

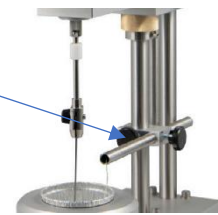

1.2 General view of your device

The GT300 is available in three versions. Without temperature control, with Peltier effect air-cooled and with electric heating.

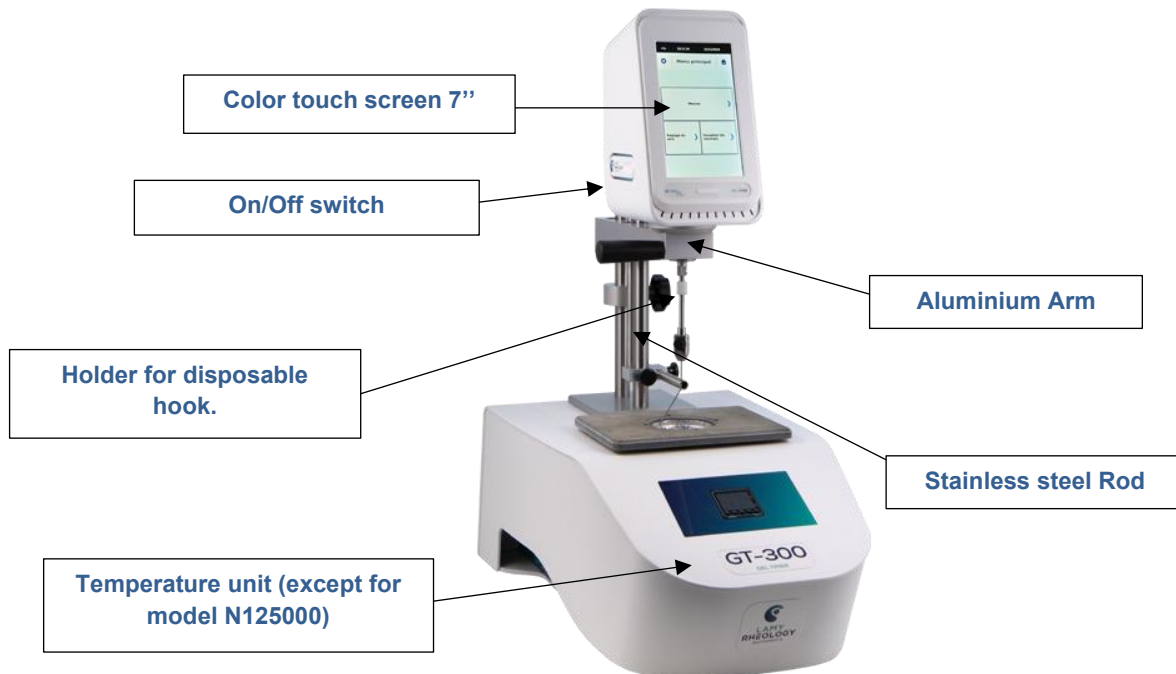

Color touch screen 7"

On/Off switch

Holder for disposable hook.

Temperature unit (except for model N125000)

Aluminium Arm

Stainless steel Rod

Available models:

PN Instruments	Designation Instrument
N125000	GEL TIMER GT300 PLUS without temperature control
N125100	GEL TIMER GT300 PLUS electrical heating (Room to +300°C)
N125200	GEL TIMER GT300 PLUS electrical heating (Room to +300°C) with programmer
N125400	GEL TIMER GT300 PLUS with Peltier (+15 to + 60°C)
N125500	GEL TIMER GT300 PLUS with Peltier (+15 to + 60°C) with programmer
N125600	GEL TIMER GT300 PLUS with Peltier (0 to + 150°C)
N125700	GEL TIMER GT300 PLUS with Peltier (0 to + 150°C) with programmer

The temperature controller that equips the models N125100, N125400 and N125600 is the following:

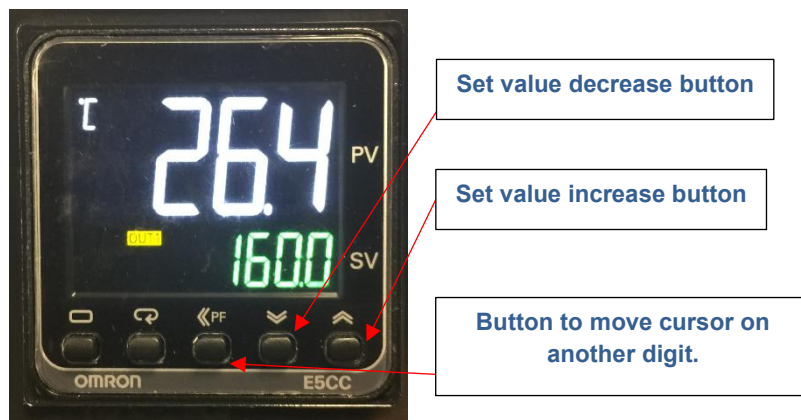

For models N125200, N125500 and N125700 please refer to section 2.9 to know how you can manage temperature of unit.

- **TOUCH Screen.**

The new GT300 series is equipped with a 7" colour touch screen. It gives you greater working comfort and a clearer view of your data and analysis results.

- **On / Off switch.**

Always with the aim of improving your experience, LAMY RHEOLOGY has decided to equip its entire range PLUS with an On/Off button. It has been placed on the back of the device for greater intuitiveness.

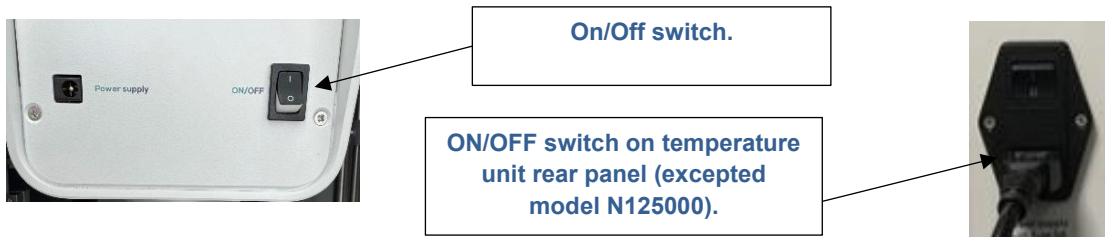

- **Aluminium arm.**

The aluminium arm is equipped with the clamping knob allows you to maintain the measuring head at the highest position and a handle for easy handling. The measuring head is fixed to the arm by two screws on each side of the motor shaft.

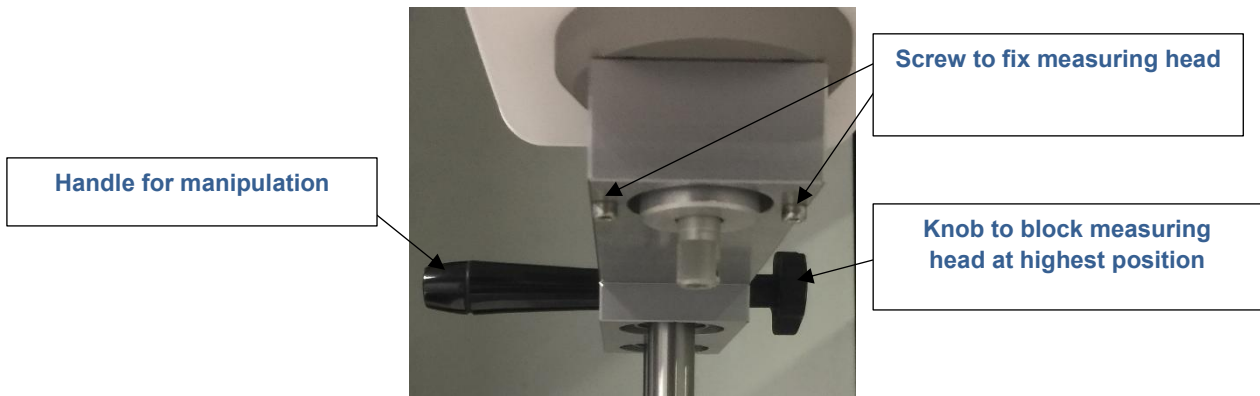

- **Stainless steel rod.**

The rods of the GT300 are made of stainless steel for a solid hold of the measuring head. They have a very long life. One of them is equipped with a ring with a tightening knob. It is used as a stop for a repeatable installation during measurement.

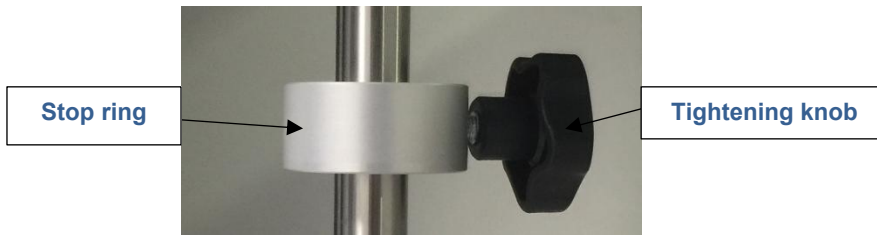

- **Anodized aluminum support (model N125000)**

The support is entirely made of anodized aluminum. It gives our instruments perfect stability (the maximum temperature allowed on the white part is 50°C).



- Support with temperature control (Model: N125100, N125200, N125400, N125500, N125600 and N125700).

The plate placed on the temperature unit is made of composite acting as a thermal barrier and thus reduces the risk of burns for the operator. It is fixed with four screws.



1.3 Connections

According to your order, rear panel of device get these available connections.

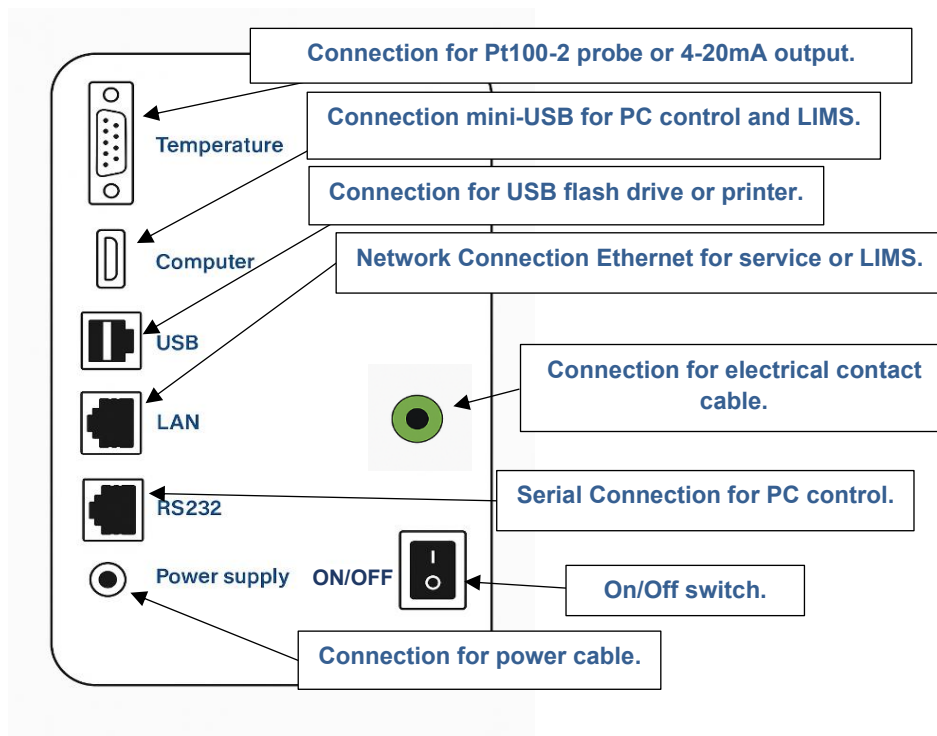

For models with temperature, the connection is as follows:

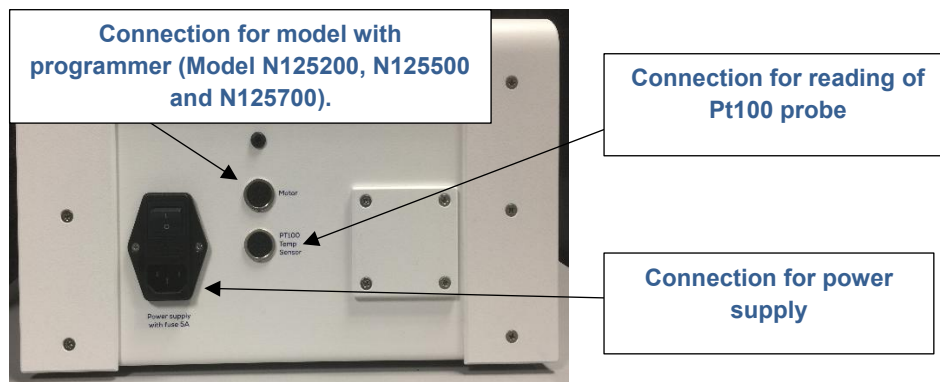

1.4 Specifications

Type of instrument: Rotating springless instrument with 7" Touch screen

Rotation speeds: Unlimited number of speeds between 0.3 and 1500 rpm

Torque range: From 0.05 to 30 mNm.

Accuracy: +/- 1 % of the full scale

Repeatability: +/- 0,2 %

Display: Viscosity – Speed – Torque – Time - Temperature - Choice of viscosity units: cP/Poises or mPa.s / Pa.s

Language: French/English/Russian/Spanish/Turkish/German/Italian.

Compatible measuring system: Disposable Hook.

Supply voltage: 90-240 VAC 50/60 Hz

Connection: USB, mini-USB, RS232 and Ethernet.

Options: See brochure

Dimensions and weight: GT300 without temperature unit (N125000): D320 x W200 x H650 mm. Weight: 14 kg

GT300 with temperature unit: D610 x H700 x W340 mm. Weight: 22 kg.

1.5 Installation

Your device should be installed in a clean, vibration-free environment. Even if no level is necessary, choose a stable and flat table.

The installation of the GT300 is very simple. The measuring head is already screwed on the stem, it is sufficient to put the instrument on a stable table. No level of the device is needed.

1.5.1 All models

Connect your device by plugging power cable on to rear panel of device. And cable for software connection when it is provided.

Click on button On/ Off from behind your device to switch on (see section 1.3).

If you are using a breakable thermocouple, go to section 1.5.3.

1.5.2 Models with temperature control (N125100, N125200, N125400, N125500, N125600 and N125700).

Connect the power cable (see section 1.5.1) of GT300 head. Connect the temperature reading cord (blue): SUB-D 15 connector on rear panel of the RM PLUS to the DIN plug on the back of the temperature stand. Please note that this cable is not available if you have ordered Thermocouple 000645.

Connect the black cable for temperature unit management between measuring head and temperature unit (only models N125200, N125500 and N125700). Connect the power cable of temperature unit.

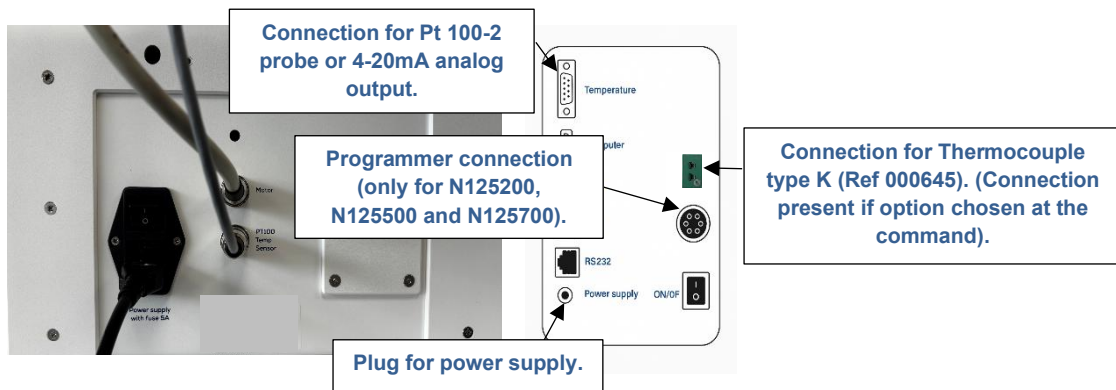

Switch on the measuring head and the temperature control unit. At the top right of the touch screen, the temperature of the Pt100 probe located in the warm-up unit is displayed. If you are using Thermocouple (000645), device will show you temperature read by this thermocouple. If this is not the case, please contact LAMY RHEOLOGY or your local agent. Check the cable between the measuring head and the temperature setting unit is correctly connected.

1.5.3 Installation and use of breakable thermocouple (PN 000645)

Depending on the delivery, a breakable thermocouple can be used to measure the temperature in the sample during the measurement. You can connect it to the port on the back of the GT300's measuring head. If displayed temperature value on display is not correct one please contact LAMY RHEOLOGY or your local agent.

When the thermocouple is used with a GT300 model equipped with a heat-up unit, it is not possible for you to display on the GT300 touch screen in same time the temperature of the thermocouple and that of the probe Pt100 of the heat-up unit.

After each measurement, you can cut the two threads above the product. For a next measurement, you must strip the ends of the two cables and twist them again.



If you have ordered holder for Thermocouple, you can install it on metallic rod and insert cable inside tube. Please don't forget that the two stripped side should not touch metallic part.







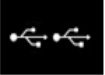

2 GETTING STARTED

Once power cable has been plugged on rear panel of device (see section 1.3), you can click on button to switch on your device (see section 1.2).

2.1 State icons

Once your device is switched on, you will see some icons on Touch Screen.

	No Device is connected to the instrument.
	Only one Device is connected to the instrument.
	Two Devices are connected to the instrument.
	Give you the temperature of probe in the sample.
	Enable to go to parameters of instrument.
	Enable to come back to Main Menu.
	Enable to come back to previous menu.

2.2 Main Menu

Main menu enable you to browse between different tabs of your instrument. Acces is always available by clicking. 

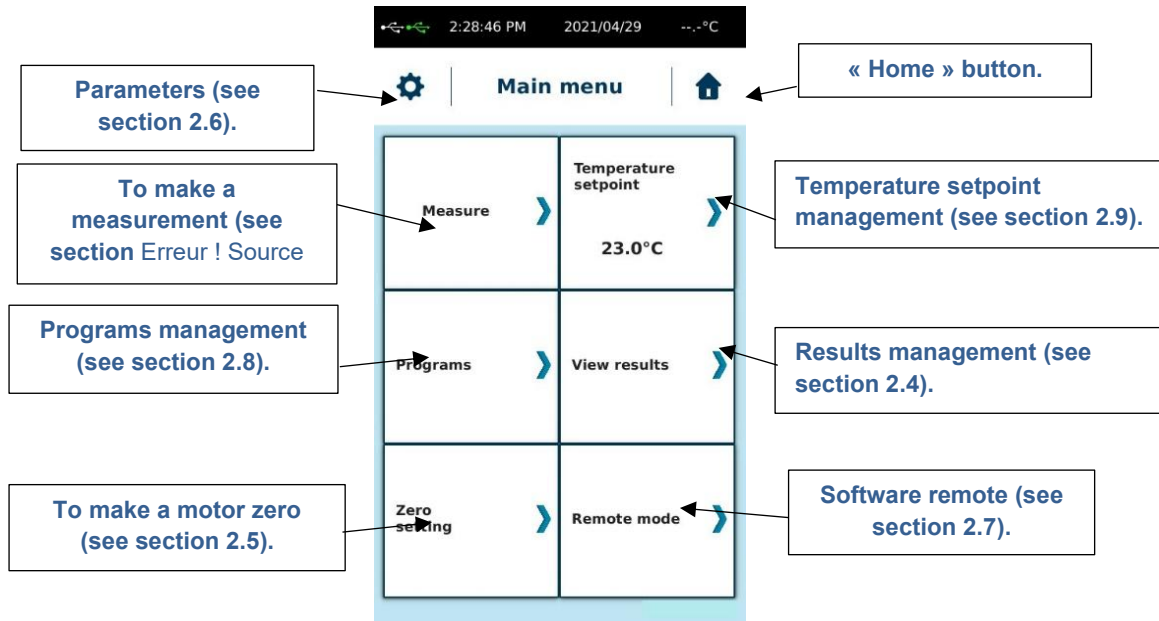

The "Temperature setpoint" button is present only for model N125200, N125500 and N125700.

2.3 Measure menu

Measure tab is central part of your instrument. Before to use it, you should install your measuring system and your sample (please see section 3).

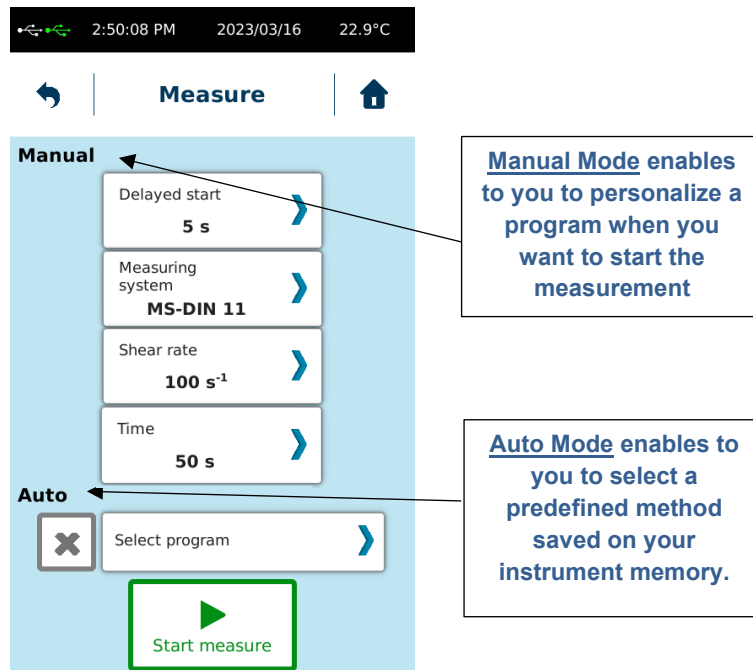

2.3.1 Manual measure mode

Manual Mode enables to choose your measurement parameters like “Measuring System”, “Speed or shear rate”, “Time of measurement” and “Delayed start”.

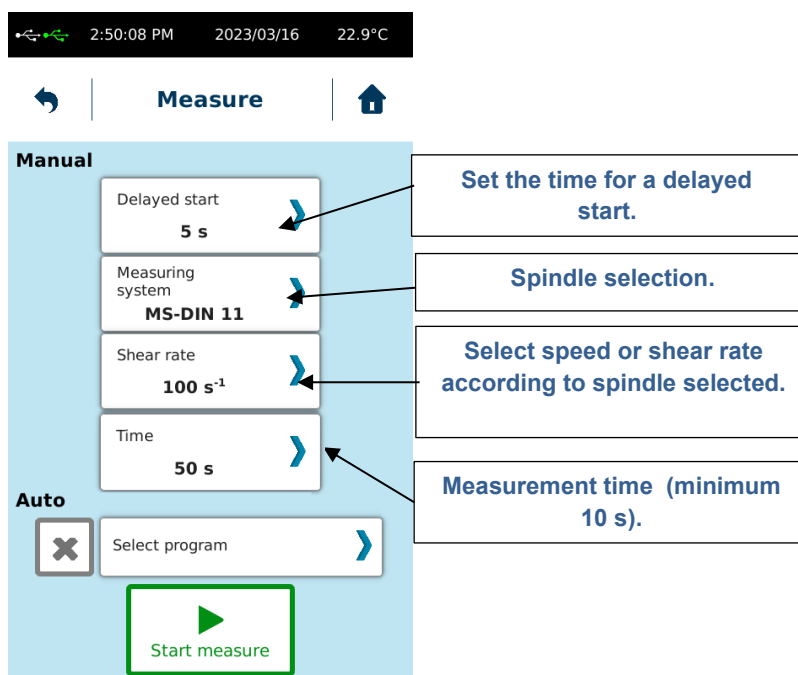

Rq : If « Time » = 0, you could modify « speed » during the measurement. This could help you to define the best conditions to work on your sample.

If your measuring system is not in list, you may have to create it. Please refer to section 2.6.6.

The GT300 PLUS is used with disposable hooks. These are called "111" or "112" when you need to select the measurement system from the list. Regarding the choice of rotation speed, the ideal range is between 0.5 and 20 rpm. Too slow a speed at the beginning of the measurement can cause problems of too low torques and a too fast speed of the couples too high when the reaction of your product accelerates. The choice of speed will depend on the kinetics of your product.

When your parameters are entered, make sure that the zero adjustment of the motor has been performed before starting your measurement. Depending on the model of instrument you have, the procedure may be different (see section 2.5).

Make sure that the measuring system you are using has been correctly installed (see section 3).

When all these checks have been carried out, you can click on "Start measure" to start your measurement.

If a delayed start has been requested, the instrument displays a countdown then switches to the next view.

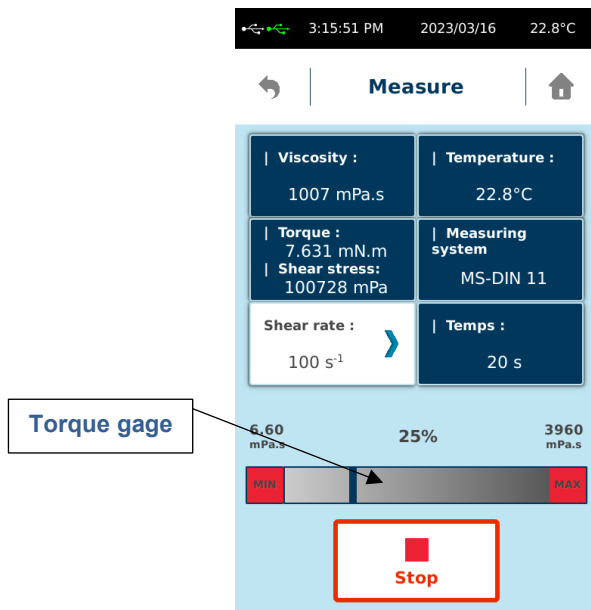

While measurement in manual mode you will see a torque gage (on the bottom side of the display). Boundaries of this gage give you minimum and maximum viscosity you can measure with your selected spindle and set speed/shear rate. You have also value in % corresponding of measured torque vs maximum torque of device. This viewing % can be set on device (see section 2.6.8).

You must verify that the measured torque is not too close to the upper or lower limit, because you can get message as “Lower Torque” or “Torque Overload” and measurement will stop automatically. If this is the case, increase speed/shear rate if you are close to the lower limit. Please decrease speed/shear rate if the torque reading is close to the upper limit.

You will find several information available on the screen such as torque (mN.m), Shear stress (Pa, can be set on section 2.6.8), temperature (° C), time (s) or viscosity (mPa.s). If the units do not suit you, you can change them in parameters (see section 2.6.5).

Then your measurement is finished, you will get this window below. You will find all data you need and get possibility to save them into internal memory or print it if printer is connected. If you choose “Save”, instrument will ask you to give a name of your measurement. You will have after possibility to read it later (see section 2.4).

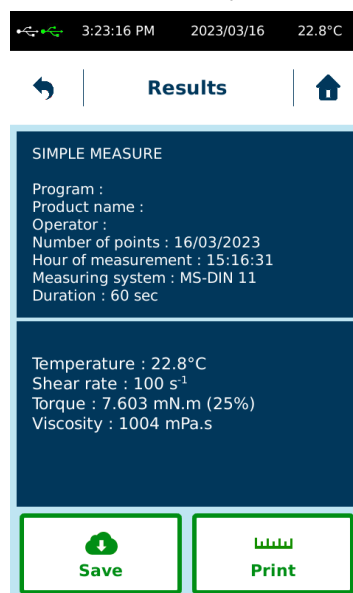

2.3.2 Automatic measure mode

Auto mode allows you to select pre-recorded programs (see section 2.8). Press "Select program" to see the list of saved method.



The extension shown next to the program name indicates the type of method according to: "*.TXT" for 1-point method, "*.PSS" for step method and "*".

Select the program to use. The instrument displays the measurement view with some information from the selected method.

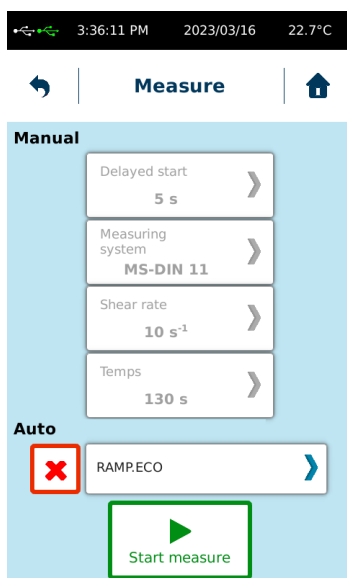

If you made a mistake in choosing the method, you can use the symbol  to allow you a new selection.

When your parameters are entered, make sure that the zero adjustment of the motor has been performed before starting your measurement. Depending on the model of instrument you have, the procedure may be different (see section 2.5).

Make sure that the measuring system you are using has been correctly installed (see section 3).

When all these checks have been carried out, you can click on "Start measure" to start your measurement.

2.3.2.1 1 point method measure mode

The results displayed during the measurement is no different from the manual mode with simple measurement (see paragraph 2.3.1).

At the end of measure, instrument show you this new window with important information according to settings of your method.

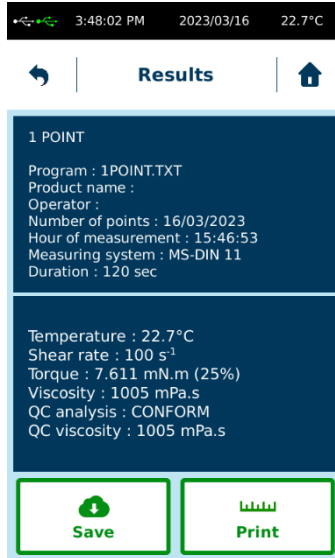

Additionally, to explication on section 2.3.1, you see type of method with name of program on first part of display. On second part of display, you show information about QC analysis if your program had it (see section 2.8.1.1). “QC viscosity” is the measured value used for “QC analysis”.

You will find all data you need and get possibility to save them into internal memory or print it if printer is connected. If you choose “Save”, instrument will ask you to give a name of your measurement. You will have after possibility to read it later (see section 2.4).

2.3.2.2 Step method measure mode

After starting the measurement using a step method, the instrument asks you for a file name to save in its memory.

If a delayed start has been requested, the instrument displays a countdown then switches to the next view.

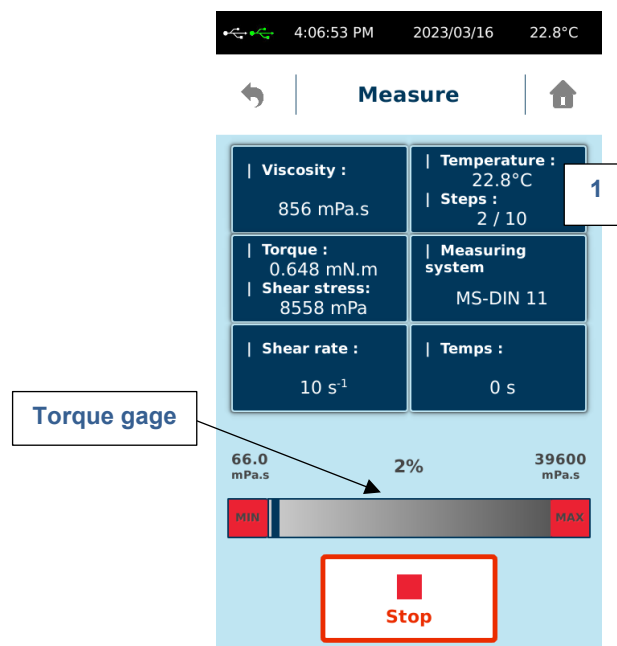

During your measurement, the instrument displays several information. The case marked "1" changes during the measurement. For models N125200, N125500 and N125700, if you have set a setpoint temperature with a start when the setpoint is reached (see section 2.8.1.2), the instrument displays the current temperature and the elapsed waiting time. When the setpoint condition is reached, case "1" switches to the display of the step in progress. For other models, case "1" directly indicates temperature measured and step in progress. To manage temperature settings with these models, please refer to section 3.2.

The instrument displays a torque gauge with displayed viscosity limits calculated according to measuring spindle used and the speed or shear rate of each step in progress. The percentage value indicates the ratio between the measured torque and the total torque of the instrument. This percentage display can be set on the device (see section 2.6.8).

You must check that the measured torque is not near the upper or lower limit, because you may get the message "Torque too low" or "Torque too high" and the measurement will stop automatically. Increase the speed or shear rate of your method's steps if you are near the lower limit. Please decrease the speed or shear rate if the torque reading is near the upper limit.

You will find several information available on the screen such as torque (mN.m), stress (Pa) (see section 2.6.8 to display this variable), temperature (°C), time (s) or viscosity (mPa.s). If the units do not suit you, you can change them in the settings (see section 2.6.5).

When your measurement is finished, you will get the window below. You will find all the data you need and will be able to print it if a printer is connected. The instrument displays the results of the "QC limits" analysis if your method includes this option (see paragraph 2.8.1.2). Note that the "QC Limits" analysis is performed on the viscosity measured during the last measured step (displayed on the screen after "QC Viscosity"). The data having been automatically saved in memory and you will then be able to read them later (see section 2.4).

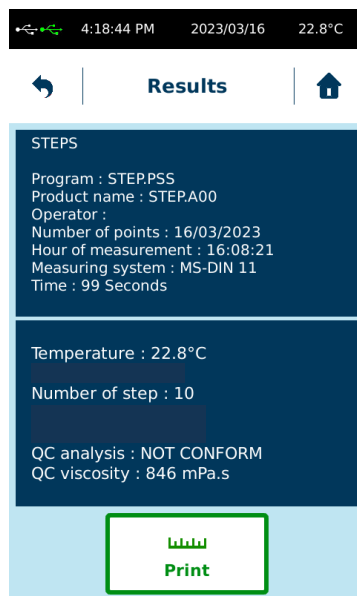

2.4 View results menu

This menu allow you to read, export or delete data from internal memory. Press on « View results » tab in Main menu.

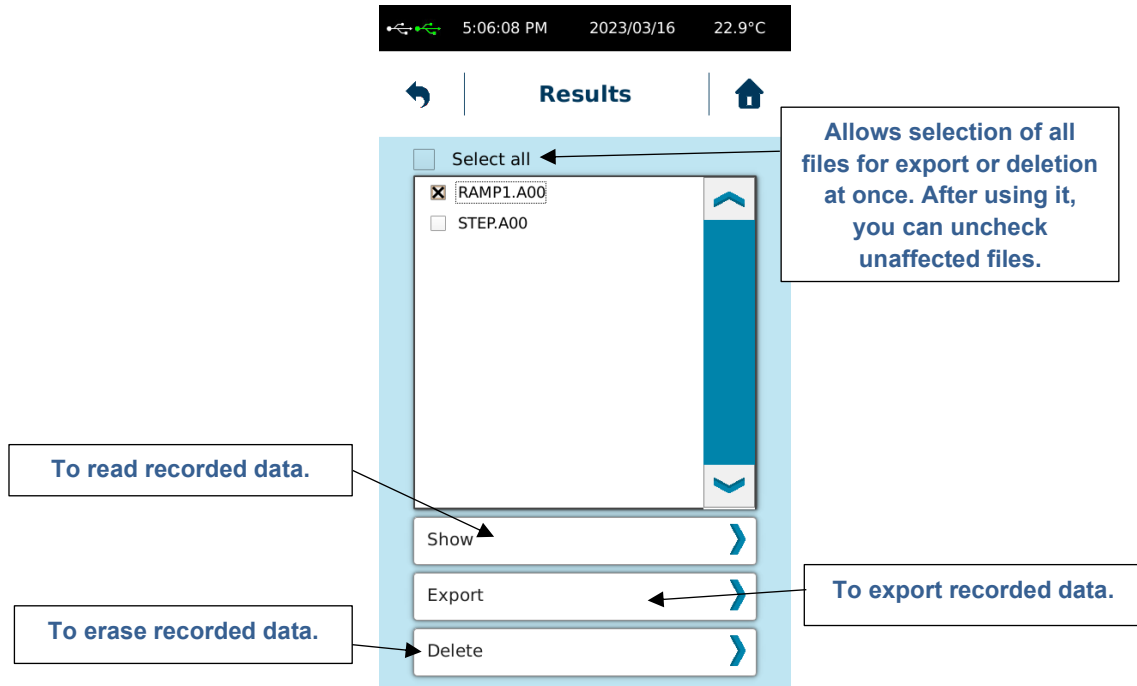

2.4.1 Show results

By clicking on this tab, you will be able to view the information concerning the selected measure. The data display format is the same as the one you get at the end of the measurement (see paragraph 2.3.2). You also have the possibility of printing or exporting depending on whether a printer or a USB key is connected to the instrument.

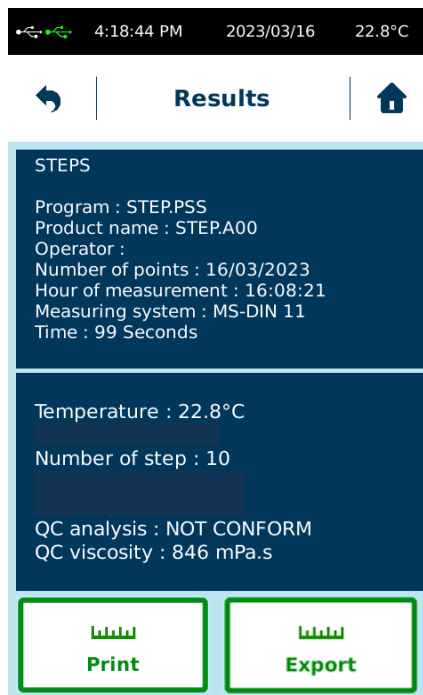

2.4.2 Export results

By clicking on "Export" you can transfer the measurements recorded to a USB key if it is connected to the back (see section 1.3). The "Select all" function allows you to export all the measurements at once.

The format of the data generated and saved by the instrument is ASCII (*.txt). Once your data has been copied to the USB drive, you can open the files using the EXCEL spreadsheet. To do this, simply copy the data from the USB key to your computer. Then open Excel, choose "File", "Open", taking care to select "All files *. *".

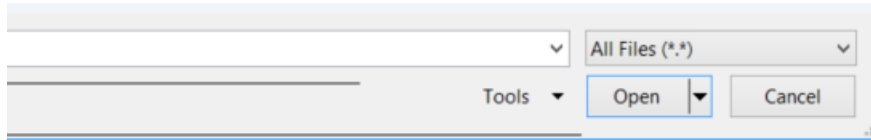

Find your file and click "Open". Excel will offer you to convert your data by displaying three successive windows.

Select "Unicode UTF8" and "My data has Header" (last selection available according Office version) and click "Next".

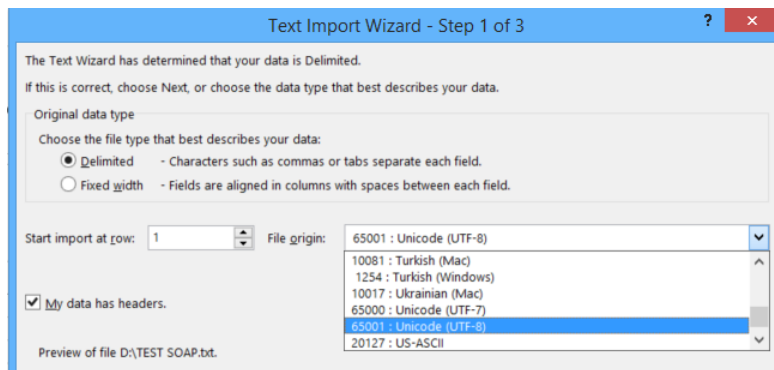

On second step, it will be necessary to choose the option "Tab" and "Semicolon" for separation of the columns. For "Text qualifier", you should set "none".

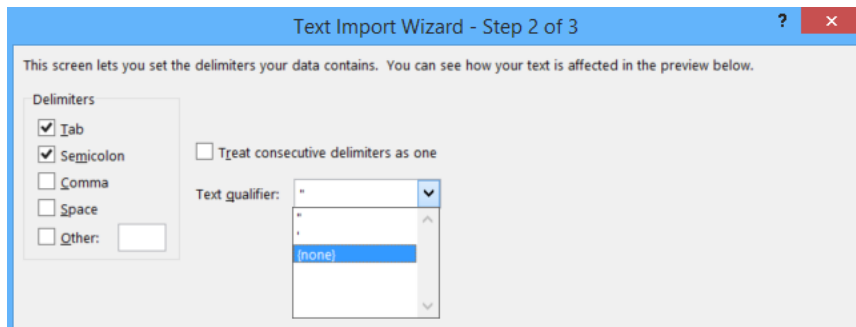

On last step, please choose "General" and click "Finish".

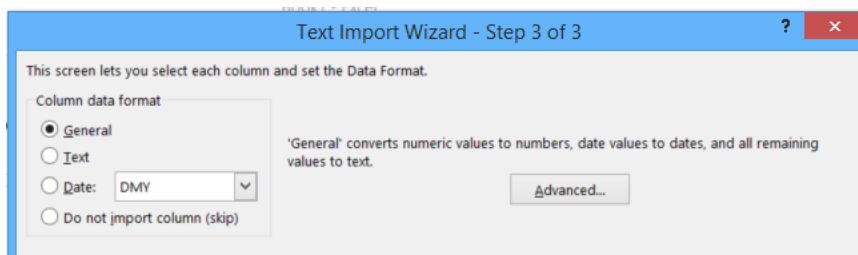

You can then see your measurement results with the possibility to save a new file in Excel format.

2.4.3 Delete results

By clicking on this tab, you can delete all the measurements recorded on your instrument. The "Select all" function allows you to delete all the measurements at once.

When you click "Delete", the recorded data will be completely deleted from the internal memory after further confirmation from you.

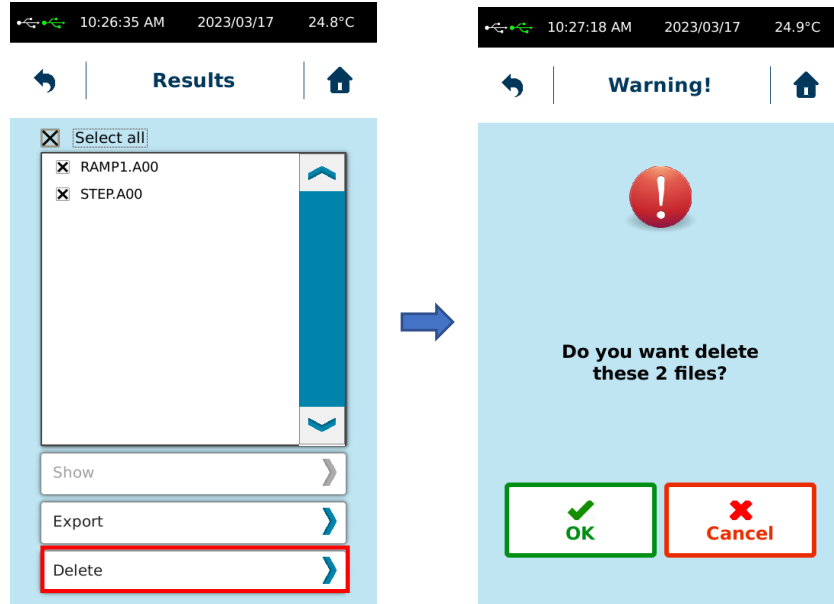

2.5 Zero setting

The zero setting allows you to calibrate your instrument to take account of the engine's empty friction.

Zero setting allows you to calibrate your instrument and take care of motor internal friction.

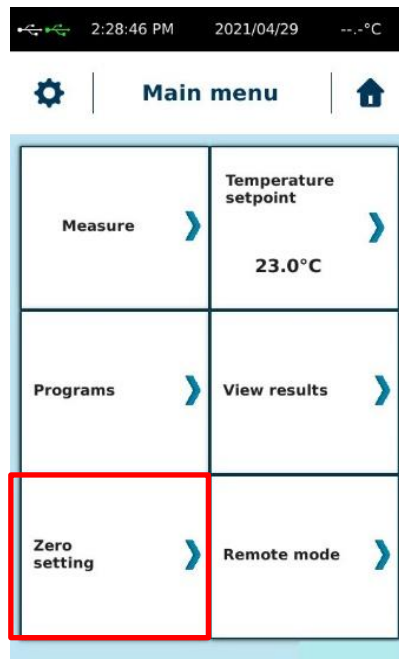

For standard instruments, this operation must be done without mobile. The rotational speed for zero adjustment is available on the same window. The rotation speed for zero adjustment can be changed to suit your needs, giving you much more accurate measurements at specific speeds near to your measurement parameters.

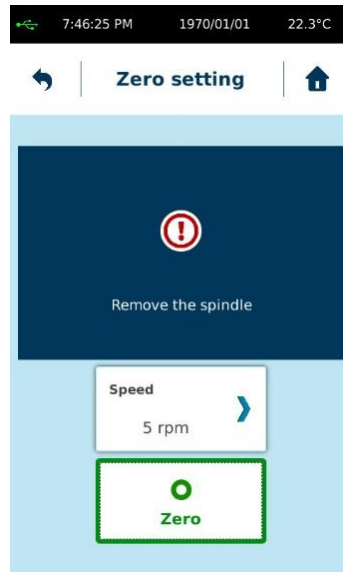

Then zero is finish you can click on OK and internal motor friction will be automatically saved inside memory of instrument. If problem occur during zero setting, please try again. If problem still present, please contact your local distributor or society LAMY RHEOLOGY.

2.6 Parameters menu

This parameters menu allows you to change settings of your device. It is reachable by clicking on icon “⚙️” in upper left corner of touch screen.

This icon is only available then you are in “Main menu”.



2.6.1 Languages

Enable you to select language of your instruments. You have choice between French, English, Russian, Turkish, Deutsche, Italian and Spanish. Then you have selected your desired language, you have to click on “Ok” and device will reboot automatically to show new language. In this menu you will be able to see Firmware version of your device.

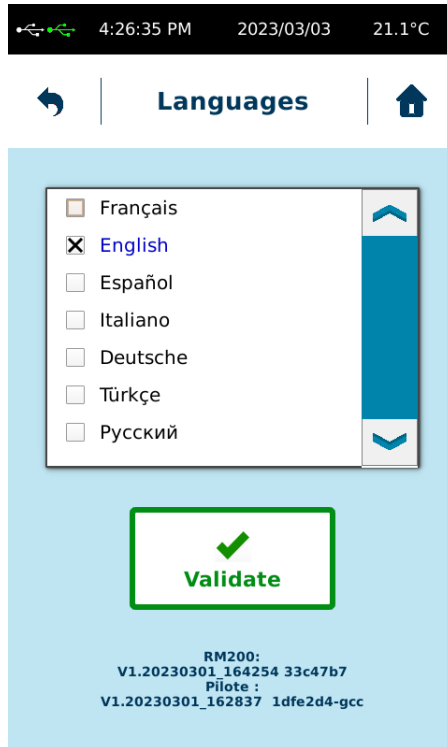

2.6.2 Date / Hour

Enable you to adjust hour and date of your instrument. On this location, you can also set date for next checking of device. Soon this date will be reached, device will show you message as device need to be checked.

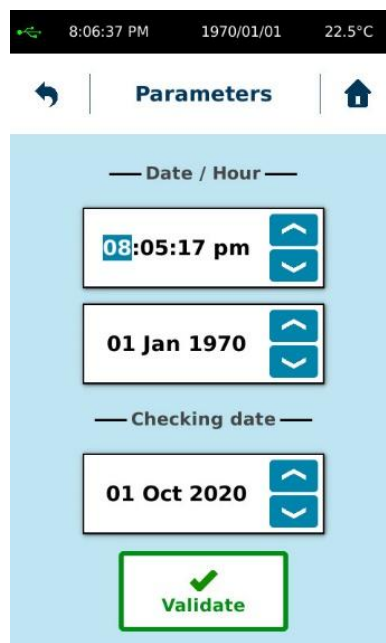

2.6.3 Sounds/Standby/Lighting

Allow you to modify sounds, lighting and activate or not the Standby mode of your instrument.

Choose if you want to get sound during using touch screen.

Choose if you want to get sound then measurement is finished.

Choose if you want to change brightness of Touch Screen.

Choose if you want to switch off automatically your device after no using. After selecting "Standby enable", you will have to set time. Your device will be switch off after this time.

The screenshot shows the 'Parameters' screen with a status bar at the top displaying '10:13:12 AM' and '07/28/2017'. Below the status bar are navigation icons and the title 'Parameters'. The main content area includes two sections for sound settings: 'keys bip' and 'buzz end of measure', each with 'Yes' and 'No' radio buttons. Below these is a 'brightness' slider with sun icons at both ends. Further down is a 'Standby Enable' checkbox and a 'Standby delay' section with a digital time display showing '00:30:00' and up/down arrow buttons.

2.6.4 User Name

Operator mode will allow you to create different operators for your instrument. The use of the operators makes it possible to identify the person making the measurement (to save name on saved file and see later who made this measurement) or lock some function on device for simple user.

Operator management must always begin with the creation of the first account, which will become the administrator and thus create or delete another operator account. Click on "Create new user with PIN code". After specifying the name and password, the administrator will be named in red in the list.

The image shows two sequential screenshots of the 'Parameters' screen. The left screenshot, timestamped '10:13:58 AM', shows a list of options at the bottom: 'Create new user with PIN code', 'Create new user without PIN code', 'Delete user name', and 'Enable User mode'. The 'Create new user with PIN code' option is highlighted with a red rectangular box. A blue arrow points to the right screenshot, which is timestamped '10:15:21 AM'. In this second screenshot, the 'Create new user with PIN code' option is no longer highlighted, and a new user entry 'SGU' is visible at the top of the list, with the text 'SGU' in red.

You can now create another operator. The account of an operator may or may not be associated with a password (here called PIN code).

To delete an account, the administrator account must be used. Select the account you want to delete from the list and click on "Delete user name".

To use the operator accounts you must activate the mode by click "Enable User mode". Device will ask you to select user name you want to use. By returning to the Main Menu, you will see the name of the operator in use. By clicking on the arrow below the name of the operator, you can switch off the instrument or change operator. Click on "Logout" and device will ask you operator account you want to use

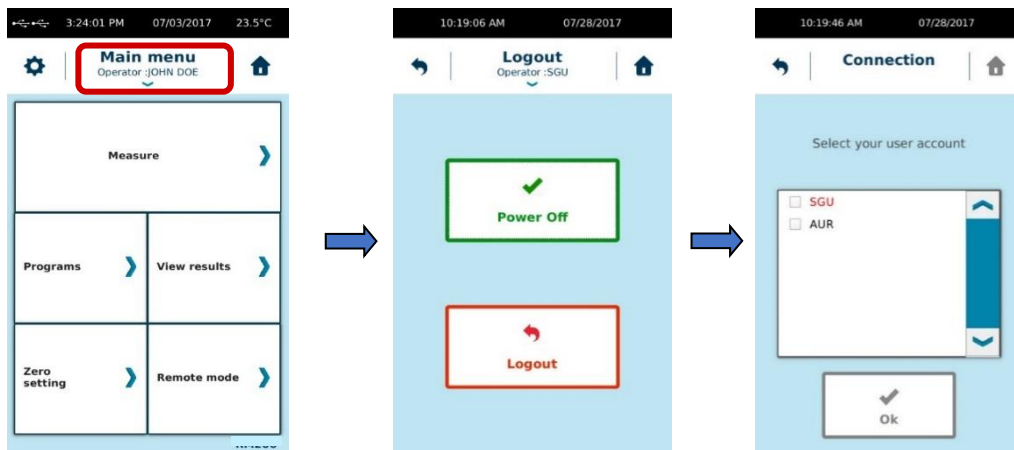

If the instrument is switched OFF and ON while operator mode is activated, device will ask you to select the operator you want use.

When User mode is enabled, some functions will be not editable for simple user as picture below shows it.

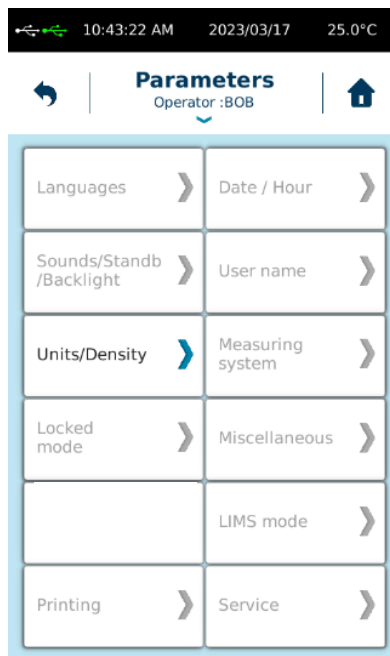

2.6.5 Units/Density

Enable you to change unit of viscosity values and to enter density value of your product to measure in order to calculate its kinematic viscosity.

If you set a density value, you will get all the time kinematic viscosity in cStoke. Please remove density information if you want to get back Pa.s or Poise for unit of viscosity.

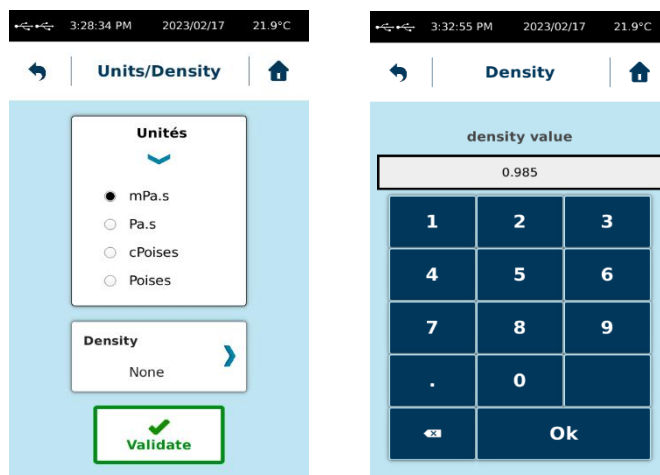

2.6.6 Measuring System

Allows you to add, copy or delete a Measurement System.

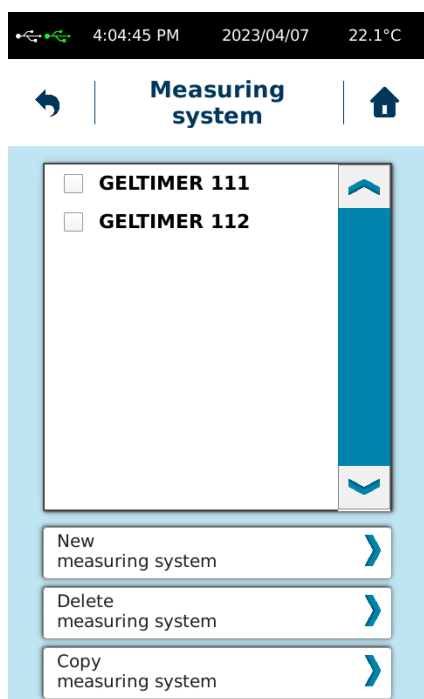

All measurement systems stored by default in memory are not removable. Only those you have created yourself can be removed. To delete a measuring system, select it from the list and choose "Delete Measuring System". If this function remains greyed out when you have selected a system, it is part of the default mobile stored in the instrument's memory.

To add a new measuring system, you can use "New measuring system" or "Copy measuring system" functions. Device will ask you name and constants for this measuring system. In case of copy, device will propose you to keep constant from previous measuring system but you can modify them.

You are not allowed to change the constant of an existing measuring system. If you want to use a new constant for an existing measuring system, you have to copy and modify it. Note that the KD constant is used to convert rotational speed to shear rate and K τ to convert torque to shear stress. Shear rate and shear stress are used to calculate the viscosity value. If you use a different constant value, you will get a different viscosity result.

Here is the list of constants used for measuring systems compatible with the instrument.

SYSTEM	Ktau / 1 mNm in Pa	Kd / 1 RPM in S-1	Ri / Ra
GELTIMER 111	155	1	1
GELTIMER 112	140	1	1

2.6.7 Locked Mode

This option allows you to block measuring parameters. It should be set by an administrator or responsible of the device.

This function is not comparable to the "User name" menu (please see section 2.6.4). It should be use if you want to protect measurement settings on your device. All settings will be not lock by this function. You will see below which settings are concerned.

This function will block also parameters for measure. In this way, if you want to use all the time same parameters for measurement, you should enable this locked mode to be sure that nobody will change settings for measurement.

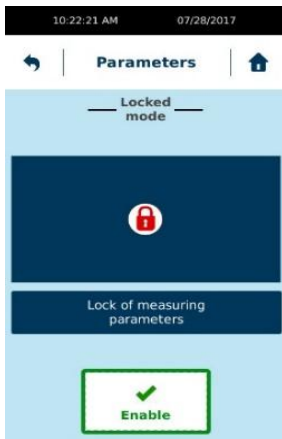

When you click "Enable", the instrument will ask you to save a 4-digit code that will be required to disable this protected mode. Each activation is independent and can be done with a different code. The protected mode is indicated by the presence of a padlock-like icon. **BUT TO DISABLE THIS LOCKED MODE, YOU SHOULD USE 4-digit CODE USED TO ENABLE IT.**

Once protected mode is activated, you will see this icone on instrument's screen (see picture below). Protected mode protect programs, measuring parameters and some menu as shown on pictures below.



To disable "Locked mode", you must return to service and "Locked mode" and click on "Disable" by entering the 4-digit code.

2.6.8 Miscellaneous

This menu allow you to select temperature probe used by device on display and measuring file. You find also information about duration when device is turned ON (Operating time) and time spent for measure (measuring time).

"Torque Trigger" allows user to set value of torque to stop automatically the measurement. As explain to the first section (see 1 Introduction), torque value and speed are used to calculate viscosity value. Link to constant for each spindle GELTIMER 111 and GELTIMER 112 (see section 2.6.6) and speed, torque value will correspond to viscosity value. So set device to stop at specific torque value is similar to stop at viscosity value to get specific time.

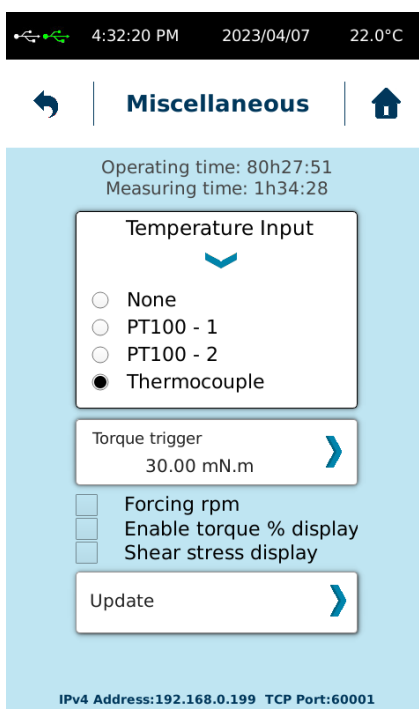

Regarding the box "Temperature input", you have four possibilities:

- "None" means that no probe is used to display the temperature on the GT300 PLUS screen
- "Pt100-1" is normally a temperature sensor directly installed on the measuring head next to the motor axis. This is not available on the GT300 PLUS.
- "Pt100-2" allows the display of the temperature read by the probe located in the heat-up unit. This is the default setting for all GT300 PLUS models with temperature control.
- "Thermocouple" must be used when a thermocouple is connected to the back of the measuring head. This is particularly the case when the thermocouple breakable is used to directly measure the temperature of the sample.

Forcing rpm allow user to set rpm instead shear rate. But in case of Gel timer hook 111 and 112, selection will be done in rpm automatically without enabling of this function.

Enable torque % display allows device to show percentage of torque according maximum torque of device.

Update allow you to update device with new firmware. Please don't use this function only if service person ask you.

"Shear stress display" function will provide you shear stress value while measuring.

On bottom part of this view, you see information about network identification of this instrument. It helps you to identify instrument when you want to use LIMS function (see section 2.6.9). These parameters can be changed in menu Service (check with your local contact or Lamy Rheology to provide you access).

2.6.9 LIMS mode

This menu allows you to select format of data for LIMS function. Like this you will be able to collect the data stored inside memory of instrument under desired format. The connection used will be Ethernet (LAN) or USB in rear panel of instrument. IP address of instrument for LAN connection can be changed in service menu. To do that, please contact LAMY RHEOLOGY or your local contact to provide you password for access.

Intervall time will be used by device to store data point inside memory after defined time for LIMS function.

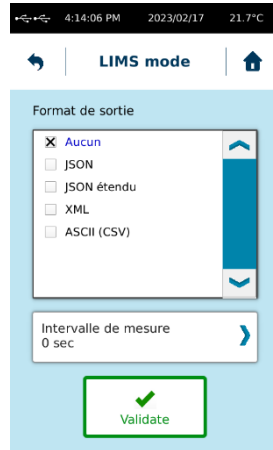

2.6.10 Printing

This menu allows you to connect a printer, print a test page, and choose the print interval time you want during measurement.

The instrument can be connected to all printers with a PCL5 print protocol. This includes many A4 printers. The connection is made to the "USB host" port on the back of the instrument.

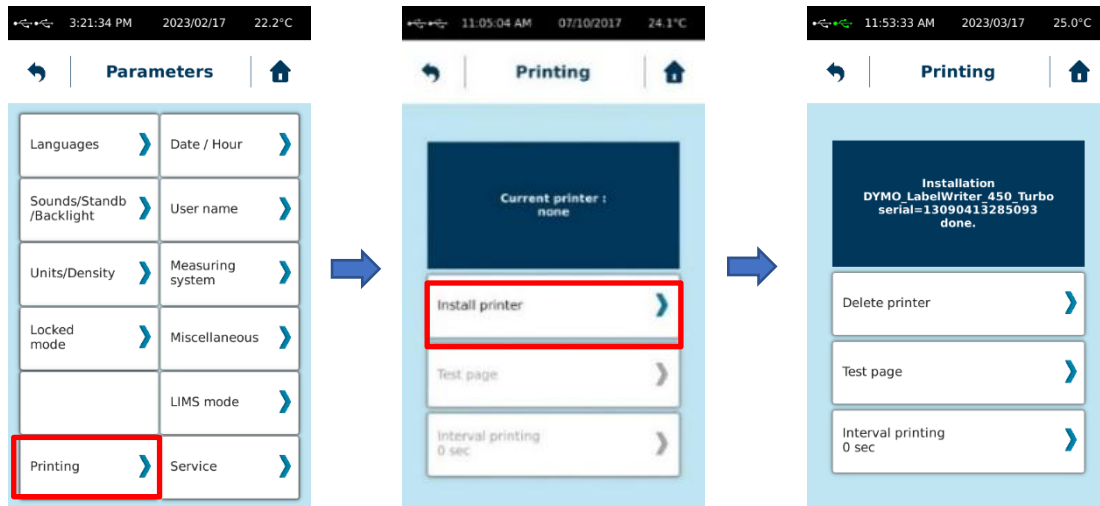

Once the printer is connected, simply click on "Install Printer".

You can also print page for test or set time interval for automatic printing. Then you print data at the end of measure or a saved file, you will have only information shown on device screen as final result. If you want to have more data printed, you have to select "Interval printing" time to get data printed between start and end of your measurement.

2.6.11 Service

Reserved to LAMY RHEOLOGY or local partner engineers.

2.7 Remote mode menu

This mode enables to drive instrument by external RheoTex software (supplied on option) or for LIMS connection (see section 2.6.9). This function is available on the main menu.

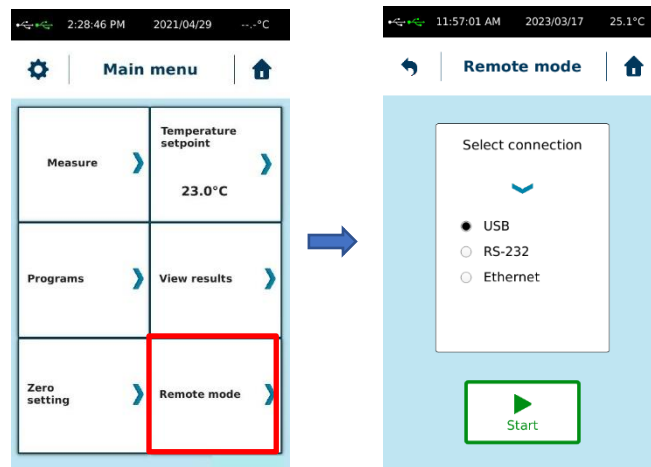

Once the device is connected to the PC, you must select the type of port (USB - RS232 for RheoTex or USB – Ethernet for LIMS) and click on "Start" to launch the communication. As long as communication is not established, a "Waiting Connection ..." message appears on the screen. Then launch the software and check that the screen switches to the display below. If this is not the case, check the connections and make sure that the COM port number set in the default settings of the RheoTex software is correct and identical to that recognized by WINDOWS in "Control Panel", then "System and "Device Management" (see the operating instructions for the RheoTex software).

2.8 Programs menu

In the programs tab you will be able to configure, modify or delete your measurement methods. The saved programs can be found in the "Auto" tab of the "Measure" menu (see section 2.3.2).

When you select the "Programs" function, you get a new window where you can see your recorded methods and functions as "Create program", "Edit Program" or "Delete a program". The "Select all" function can only be used for the deletion of methods.

The extension after the program name indicated the type of method according to: " *.TXT" for 1 point method, "*.PSS" for step method.

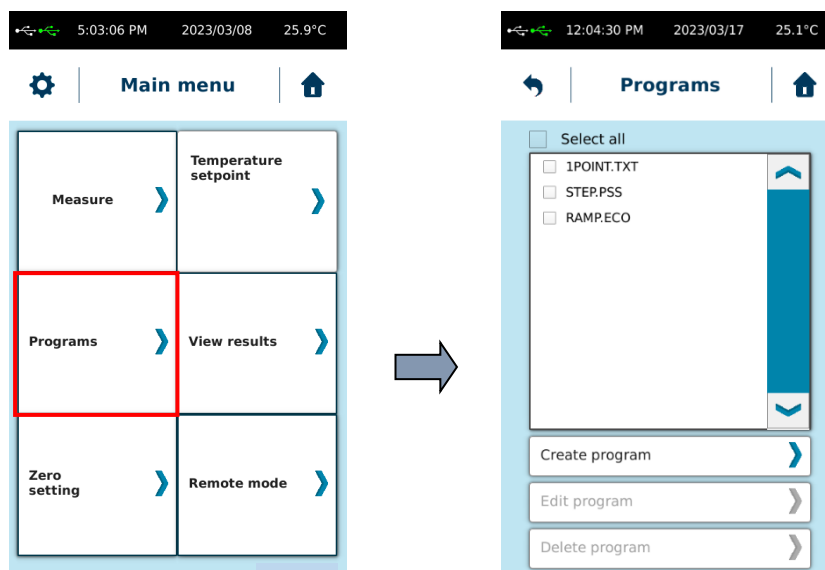

2.8.1 Create new program

By selecting "Create program", the instrument displays the following view.

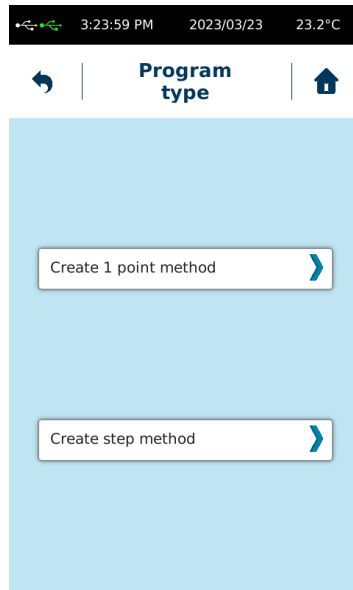

The "1 point method" makes it possible to measure your product viscosity at constant rotation speed or constant shear rate during a defined time. The instrument will display measured viscosity at the end of this measurement time.

The "Step method" allows you to fix measurement intervals at different rotation speed or shear rate in order to obtain viscosity values under different shear conditions. It also makes it possible to obtain a flow curve by fixing interval by interval the shear rate and time.

2.8.1.1 1 point method

When you choose 1 point method, the instrument displays the following view.

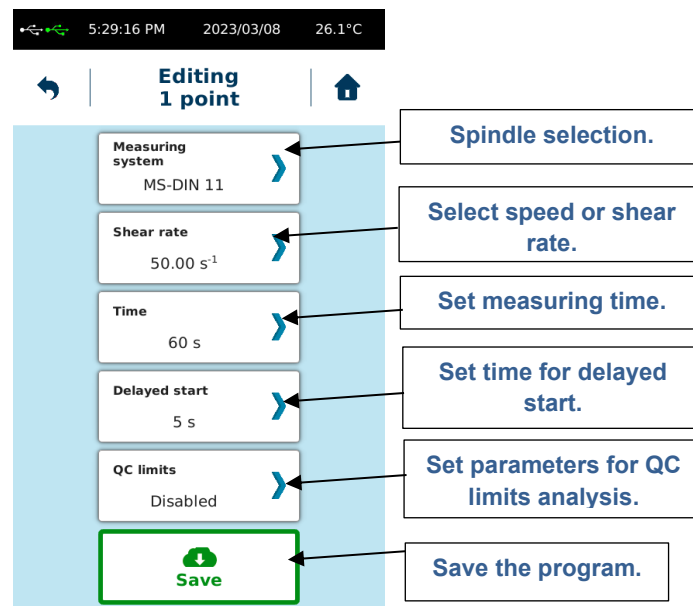

When creating a new method, the next button is activated after your validations progresses.

The "Delayed start" function allows you to set a waiting time before the measurement. This time will be deducted as soon as you launch the measurement (see section 2.3).

The "QC limits" function makes it possible to verify that the measured viscosity value is between two limits that you have previously set. When choosing this function, the instrument displays the following view.

The screenshot shows the 'QC limits' configuration screen. At the top, there is a status bar with the time 5:45:18 PM, date 2023/03/08, and temperature 25.9°C. Below the status bar are navigation icons for back, 'QC limits', and home. The main content area includes:

- An 'Enable' checkbox with a checkmark, indicated by a callout: "Enable the 'QC limits' function in the method."
- Two input fields: 'Viscosity' set to '1000 mPa.s' and 'Tolerance' set to '+/- 5.0%'. A callout points to the tolerance field: "Set the percentage tolerance to calculate the lower and upper limit from the target value."
- A 'Compliant message' field containing the text 'GOOD'. A callout points to this field: "Indicate the message to be displayed by the instrument at the measurement end according to the viscosity value is within the tolerance or not."
- A 'Not compliant message' field containing the text 'NOT GOOD'.
- A green 'Validate' button at the bottom.

A callout on the left side points to the 'Viscosity' field: "Set target value for viscosity check."

Do not forget to activate the "QC limits" function before validating to exit this window, otherwise the information will not be saved. At the measurement end according to the viscosity value is within the tolerance or not, the instrument will display the message that you have indicated in the "Compliant message" or "Not compliant message" fields.

Once you have finished setting up your method, you can save it by choosing "Save".

2.8.1.2 Step method

When you select step method, you will get the following view.

The screenshot shows the 'Editing step' configuration screen. At the top, there is a status bar with the time 10:40:33 AM, date 2023/03/09, and temperature 24.8°C. Below the status bar are navigation icons for back, 'Editing step', and home. The main content area includes:

- 'Measuring system' set to 'MS-DIN 11'. A callout points to this field: "Spindle selection."
- 'Pre-shear duration' set to '5 sec'. A callout points to this field: "Set Pre-shear time."
- 'Shear rate for pre-shear' set to '5.00'. A callout points to this field: "Fix the speed or the shear rate of pre-shear phase."
- 'Number of steps' set to '11'. A callout points to this field: "Set steps for method."
- 'Datapoint number by step' set to '1'. A callout points to this field: "Set point number by step."
- 'Options' field with a right-pointing arrow. A callout points to this field: "Set method options."
- 'Delayed start' set to '0 s'. A callout points to this field: "Set time for delayed start."
- 'QC limits' set to 'Enabled'. A callout points to this field: "Set parameters for QC limits analysis."
- 'Temperature' set to '30.0 °C'. A callout points to this field: "Set temperature for method."
- A green 'Save' button at the bottom.

When creating a new method, the next buttons is activated after your validations progresses.

The "Delayed start" function allows you to set a waiting time before the measurement. This time will be deducted as soon as you launch the measurement (see section 2.3).

The "Temperature" button is only present for models N125200, N125500 and N125700. This is the case when the instrument has been delivered with a programmable temperature regulation. By default, this function is not accessible. If you acquire a temperature control device later, we invite you to contact LAMY RHEOLOGY to activate this function.

The "QC limits" function is identical as defined in paragraph 2.8.1.1.

When you select the "Number of steps" button, the instrument displays a new view.

The screenshot shows the 'Step editor' screen with a list of 10 steps. Each step is represented by a checkbox, a step number, a duration, and a shear rate. The first step is selected. Below the list are buttons for 'Add new step', 'Delete step', 'Edit duration', and 'Edit value'. Callouts provide the following explanations:

- Allows you to select the step for copy, edit or delete.** (Points to the checkbox of the first step)
- To delete selected step.** (Points to the 'Delete step' button)
- Allows you to change the speed or shear rate of selected step.** (Points to the 'Edit value' button)
- Allows you to copy selected step and then add it after it.** (Points to the 'Add new step' button)
- Allows you to modify the selected step duration.** (Points to the 'Edit duration' button)

Once changes have been done, you can use the button to return to the previous screen. The instrument will display the new number of steps.

The "Options" function allows you to integrate a rheological analysis or a temperature setting condition as described in the following view.

The screenshot shows the 'Options' screen with two main options: 'Decreasing ramp' and 'Start at temperature'. A 'Validate' button is at the bottom. Callouts provide the following explanations:

- Select this function if you want the instrument to chain the same succession of steps but in the opposite direction.** (Points to the 'Decreasing ramp' checkbox)
- Allows you to wait for the temperature defined in the method to be reached before starting the measurement (only for models N125200, N125500 and N125700).** (Points to the 'Start at temperature' checkbox)

The "Start at temperature" option is only interesting if temperature control is activated on your instrument (for models N125200, N125500 and N125700).

The "Decreasing ramp" option is interesting if you want to use the step method to generate a flow curve. This descending part will be carried out following the first succession of steps. The term "Decreasing" means that the instrument will decrease the speed or the shear rate. It is therefore important that, during the first succession of stages, the speed or the shear rate are increasing.

2.8.2 Edit program

This function allows you to modify an existing method. Select a method by checking the corresponding box. The "Edit program" function becomes active and allows you to navigate through the parameters in the same way as described in paragraph 2.8.1. After modifying the method, you have the option of saving it under another name or overwriting the existing method name.

2.8.3 Delete program

This function allows you to delete a method from the instrument memory. Select the method concerned by checking the corresponding box. You can delete them all at the same time by selecting the "Select all" function.

2.9 Temperature setpoint menu

This function is available in the main menu.

As described in paragraph 2.3, this function is only available for models N125200, N125500 and N125700. For other models, please refer to section 3.2.

This mode does not allow temperature ramps to be carried out via the instrument. For this type of method, the use of RheoTex software is required.

Contrary to the use of the setpoint in a measurement method (see section 2.8), the use of this function is useful for controlling the temperature setting unit without performing a measurement. So, you can precondition your sample to the right temperature before starting the measurement.

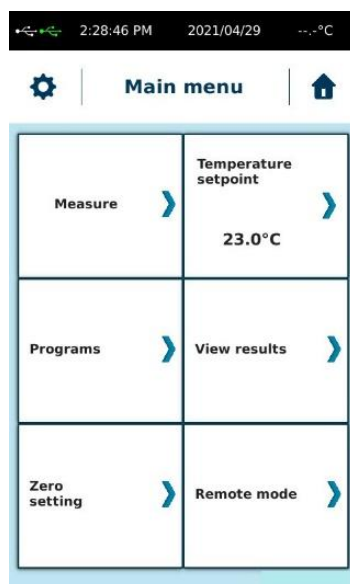

3 MEASURING WITH YOUR DEVICE

This section will show how use the different measuring system with your device.

Instrument need to be installed before next section of this manual (see section 1.5).

3.1 Installation of measuring system

Read the installation of your measuring system in the following sections before inserting it on your device. Indeed some measuring systems require the installation of accessory before the insertion of the spindle.

As the GT-300 get only one kind of bayonet coupling system, way to install measuring bob on shaft of device is always the same.

Depending on the order, the GT300 PLUS comes with fixture and hooks. To set the hooks, please unscrew the clamping knob, insert the hook and lock it by tightening.

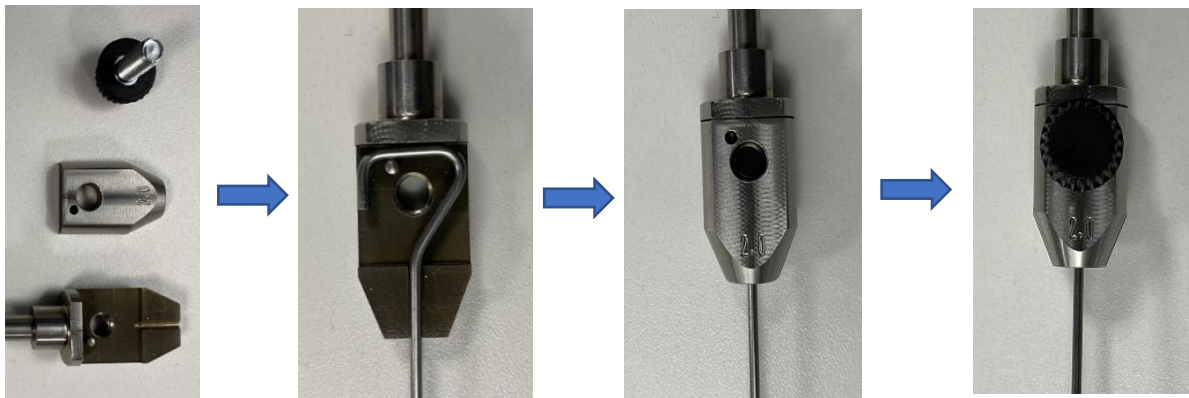

Insert the hook holder with the bayonet coupling into the motor shaft by pushing and turning slightly so that the pin is lodged in the space provided.

Make sure the assembly is well aligned by slightly rotating the assembly. If necessary, reposition the hook by twisting slightly, taking care to hold the motor shaft with your other hand to prevent damage to the motor.

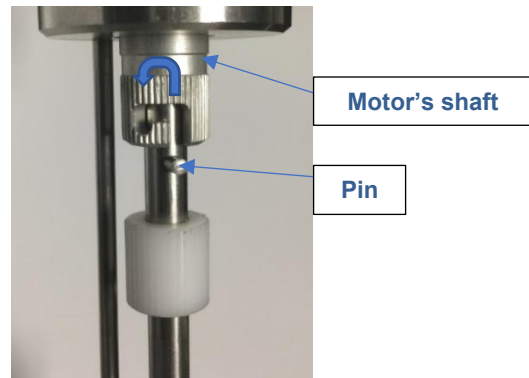

You can then set up the disposable cup that will accommodate the product.



Check that the disposable cup is touching the bottom of the well. Be careful not to burn if the bottom of the well is already in temperature. Place the stop ring on the rod at the lowest position by unscrewing it completely (see section 1.2). Lower the measuring head by holding it with the handle of the arm so that the hook is closer to the bottom and

the walls of the bucket without touching it. Block the head in this position using the screw on the arm. Check by applying a slight rotation that there is no friction between the hook and the cup. If this is the case, move the measuring head again. Once the position is final, place the stop ring just below the arm and lock it with the knob. This then allows you to raise the head to the highest position while keeping the measurement position with the stop ring.

Fill the cup with your product. Make sure that the quantity is sufficient for the hook to be immersed. The quantity needed can be judged using water first. Lower the measuring head to the stop ring. It is useless again to tighten the screw on the arm. Install thermocouple if you ordered it. And start your measurement.

3.2 Temperature settings

This section concerns only model N125100, N125400, N170400 and N125600. For other models, please refer to section 2.9.

The value read on this display is the set temperature. The value read on the screen of the GT300 PLUS is the actual value of temperature. To change the set point, press the arrows to adjust the desired temperature, the new set point will be taken into account after a few seconds without validation.

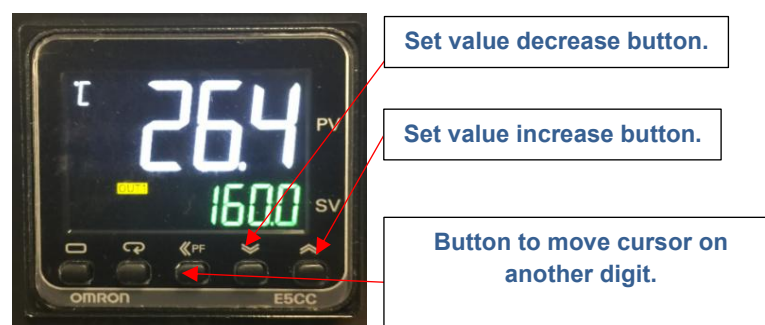

4 VERIFICATION OF YOUR DEVICE

Your instrument is calibrated at the factory with an ASTM RV2 measuring system (see calibration certificate) and a certified oil with a viscosity close to 1000 mPa.s. The verification method differs depending on the measurement system selected. You may decide to perform the verification with your own measurement systems, but it is highly recommended to use measuring systems mentioned above. If you don't have ASTM RV2 spindle, please contact your local partner or LAMY RHEOLOGY.

Viscosity measurement on a 1000 mPa.s standard silicon oil with an ASTM 2555 R2 measuring system.

- See section 3.1 for detail about preparation and insertion of spindle.
- Adjust the automatic zero in the air at 50rpm, without any spindle, until it stops (see section 2.5).
- Fill the 600ml beaker with the standard oil.
- Place the 600ml beaker in a controlled temperature unit like thermostatic bath to stabilize temperature around 23°C.
- Place the 600ml beaker above disposable cup chamber of GT300.
- Attach the spindle R2 (See section 3.1) to the device and immerse the spindle in the oil at the good level (mark on the spindle).
- Select on the instrument the measuring system R2 (see section 2.6.6 if you need to create it with constant $K_{\tau}=55.65$, $K_d=1$ and $R_i/R_a=1$), select 50 rpm for the speed, select 60 seconds for the measuring time, and start the measurement (see section 2.3).

Result at the end of the measurement must be within +/-5% of the standard viscosity value. If the measure is out, your instrument might need to be recalibrated.

Check if the error does not come from a wrong filling, a wrong zero adjustment, a wrong spindle rotation, or a wrong temperature value.



LAMY RHEOLOGY
11 A, rue des Aulnes
69410 Champagne au Mont d'Or (France)

Tel : 33 (0)4 78 08 54 06
Fax : 33 (0)4 78 08 69 44
contact@lamyrheology.com